

# 毛刷系列产品



## 什么是含磨料尼龙刷？ What is ABRASIVE NYLON FILAMENT BRUSHES?

含磨料尼龙刷是一种工业刷，主要用于去毛刺，刀口钝化和表面精整加工。

**Abrasive nylon filament brushes belong to industrial brushes, mainly for clearing burr, passivating edge and surface finishing.**

成都工研究有限公司生产的含磨料尼龙刷。尼龙丝中均匀掺入碳化硅或氧化铝磨料。根据加工要求，刷子可制成盘刷、孔刷、轮刷、笔刷和碗刷等各种型式。含磨料尼龙刷具有优良的变形恢复能力，遇水、油其性能几乎不受影响，并对大多数化学品抗腐蚀。

**Chengdu Tool Research Institute Co., Ltd produced the abrasive nylon filament brushes with equable silicon carbide and aluminium oxide abrasive in the nylon filament. The brushes can be in disk, hole, wheel, pen and bowl shape to adapt the working requirement. The abrasive nylon filament brushes with excellent displacement restoring capacity, keep unacted on water or oil even chemical's corrosivity.**

众多的含磨料尼龙丝相当于同等数量的柔性锉刀，加工零件时，可任意弯曲，自然贴合到工件轮廓上，进入沟槽，裂缝等一般工具难以进入的地方，将毛刺去掉，锐边倒钝为光滑均匀的圆弧，达到去毛刺、刀口钝化和表面精整加工的理想效果。比起喷砂、震动等工艺，该方法噪音低，无污染、利于环保。

**Numerous abrasive nylon filament equal to same quantity flexibility file, can be curve freely and joint work-piece face naturally, can enter the harder space like grooving and breaking to clean burr, to passivate edge and finish surface. Comparing with sand blast and shake, the brushes with the advantage like lower noise, no pollution, more environmental.**

含磨料尼龙刷的典型应用：

**Application of abrasive nylon filament brushes:**

汽车、摩托车行业：发动机缸盖、缸体、凸轮轴，化油器，燃料喷嘴，活塞，变速器，电池箱去毛刺；油漆、涂层前表面的精整加工等。

**Automobile Motorcycle filed: clean burr for engine cylinder head, body and crankshaft, carburetor, fuel injection nozzle, piston, transmission and battery tube. Surface finish before painting and coating.**

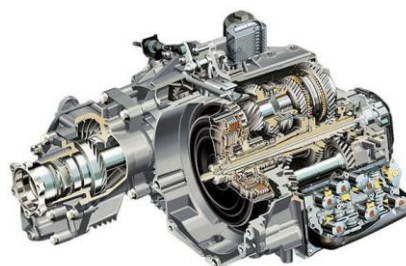

工具行业：硬质合金，金属陶瓷刀片、整体硬质合金等刀具钝化抛光。

**Tool field: polish and passivation for carbide tools, cermet tools and solid carbide tools.**



钢、铁、有色金属行业：电镀、涂层加工前，金属表面的精整加工，铝型材表

面，切断面的精整加工、去毛刺。

**Steel, iron, nonferrous metal filed: surface finish before electroplate and coating;**

**Clean burr and surface finish for aluminium profile**

**PCB(电子线路板):** 铜板表面精整加工，增加对环氧树脂的黏着功效、钻孔去毛刺等。

**PCB(Print Circuit Board):** Surface finishing on brass board, increase adhesion with epoxy resin, drill hole and clean burr, etc.

木工行业：三合板精整加工、去毛刺、以增加黏合功效；各种木地板的修整等。

**Wood filed: finishing three-ply board, cleaning burr to increase adhesion.**

加工行业：各种零件的钝化、去毛刺、表面修整等。如交叉孔、阶梯孔、内、外螺纹、齿轮等

**Machine filed: passivating, clearing burr and surface finishing for spare parts.**

**Such as: cross hole, ladder hole, internal/external hole and gear.**



本公司生产的含磨料尼龙刷，经汽车、发动机、刀具制造行业使用，完全可以取代进口产品。

**Our abrasive nylon filament brushes can replace the import products in automobile, engine and tools field.**

现有磨料丝

#### **Abrasive Filament**

含磨料尼龙丝品种 type			磨料 abrasive material
1. 4x80#	1. 12x80#	1. 12x120#	碳化硅 Silicon carbide
1. 02x180#	0. 91x240#	0. 61x320#	
0. 61x120#			
0. 48x500#	0. 3x600#		氧化铝

		Aluminium oxide
--	--	--------------------

本公司可根据用户需求，设计制造各种形式的含磨料尼龙刷

**We can special design and manufacture by user demand.**

孔刷、盘刷高效解决方案 汽车工业

**Tube brushes, disc brushes solution case in automobile filed**

**发动机缸盖 engine cylinder head**

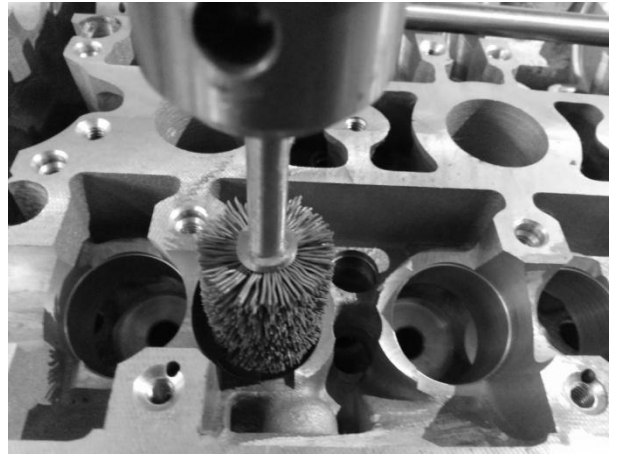
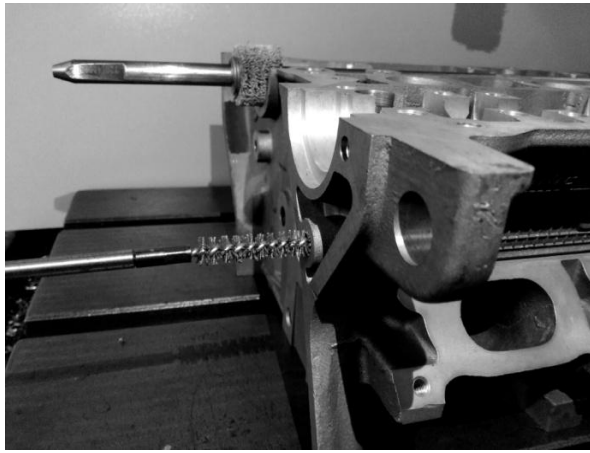

含磨料高效孔刷，缸体活塞孔、油孔 去毛刺、抛光  
毛刷材质柔软，不会出现类似砂轮或研磨带的残留物带来的气孔堵塞

**For the flexibility of filament, when using tube brushes to clean burr and polish on piston hole and oil hole, will not produce residue blocking gap hole, better than sand wheel and grind.**



含磨料高效盘，刷缸体装配面去毛刺、抛光  
能获得无与伦比的工件表面质量和效率的成倍提升

Using disc abrasive brushes to clean burr and polish on fitting face will get perfect result and double efficiency.

盘刷高效解决方案

工具行业

### Disc brush solution case in tools filed

硬质合金，金属陶瓷刀片、整体硬质合金等刀具钝化抛光。

Passivate and polish for carbide tools, cermet tools and solid carbide tools.



(本公司生产的数控钝化抛光机)

CNC passivating and polishing machine manufactured by Chengdu Tool Research Institute Co., Ltd

机械部件等的交叉孔内的微小毛刺清除

机械加工业

Cleaning the micro burr in internal of cross hole for machining field



# 工业用毛刷系列产品 孔刷

## Industrial Brush Series Tube Brush

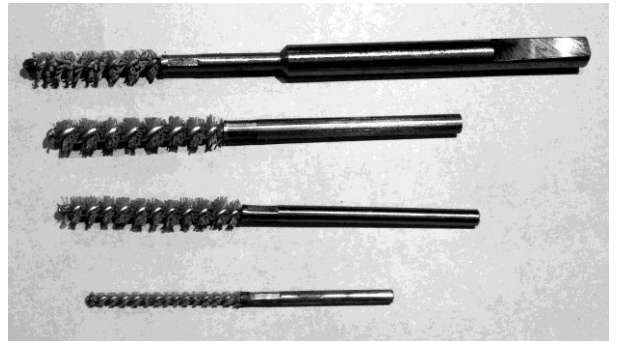
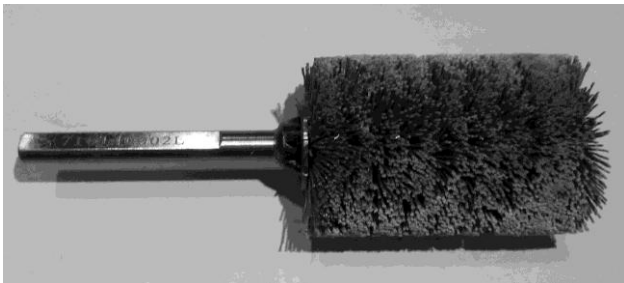
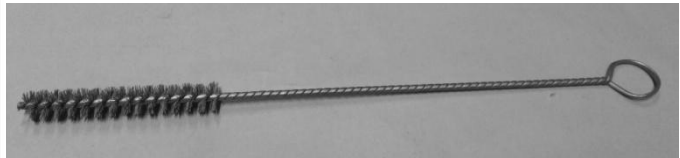
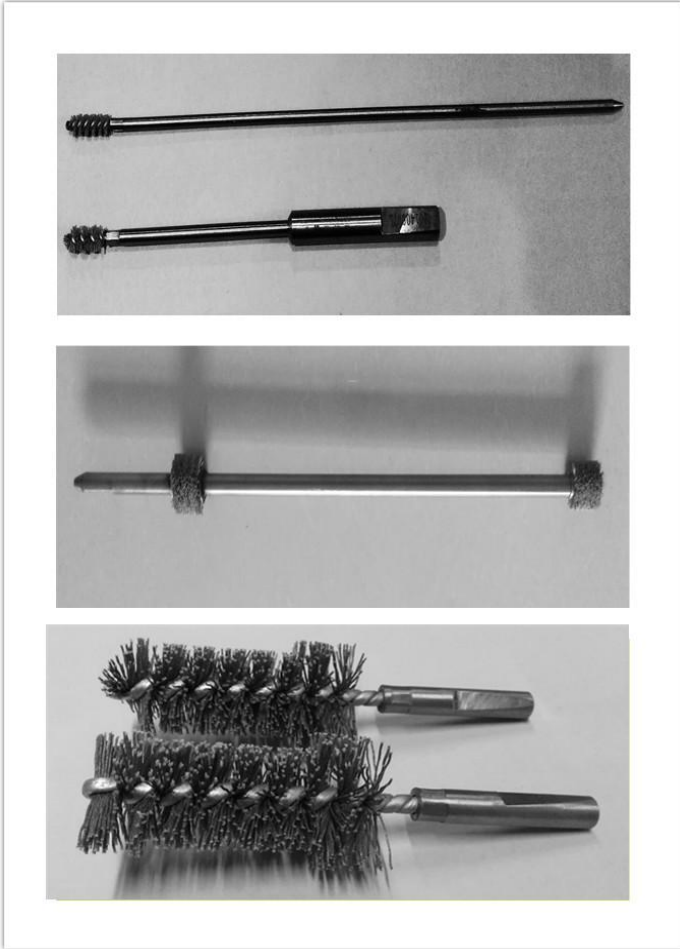

# 工业用毛刷系列产品 盘刷

## Industrial Brush Series Disc Brush

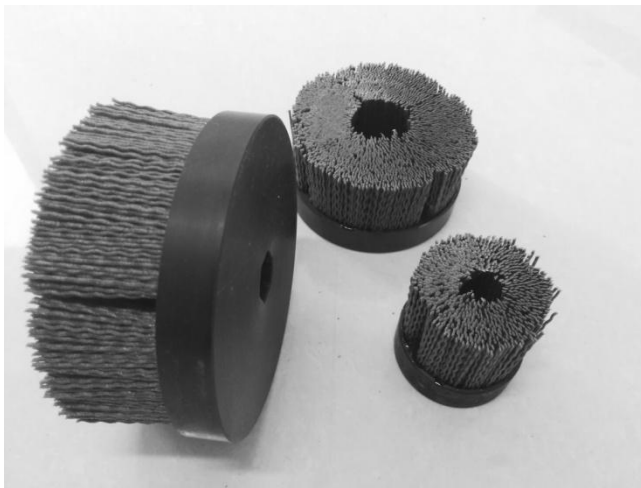
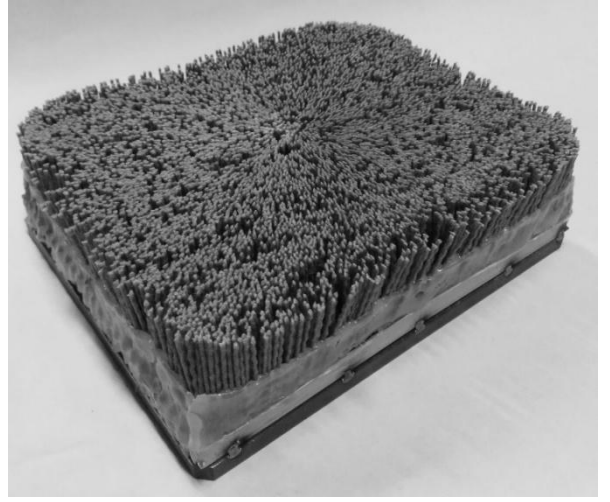
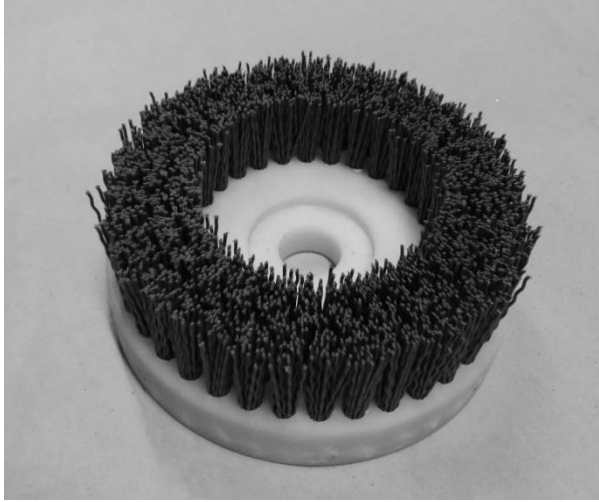

# 工业用毛刷系列产品 轮刷

## Industrial Brush Series Wheel Brush

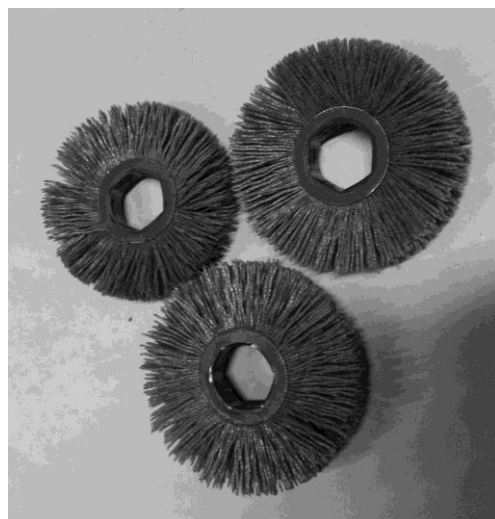
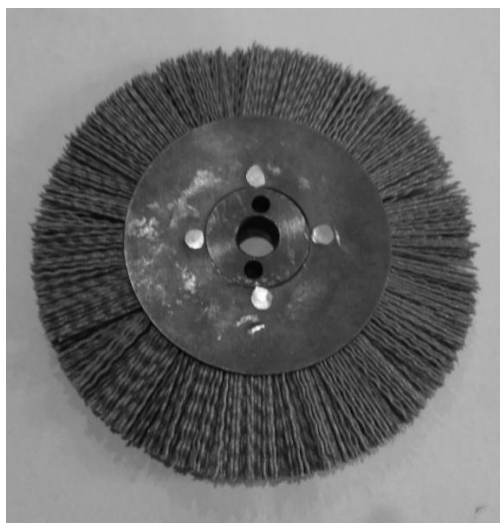



抛光刷系列产品 笔刷.排刷

**Polishing Brushes End brush and Striped brush**

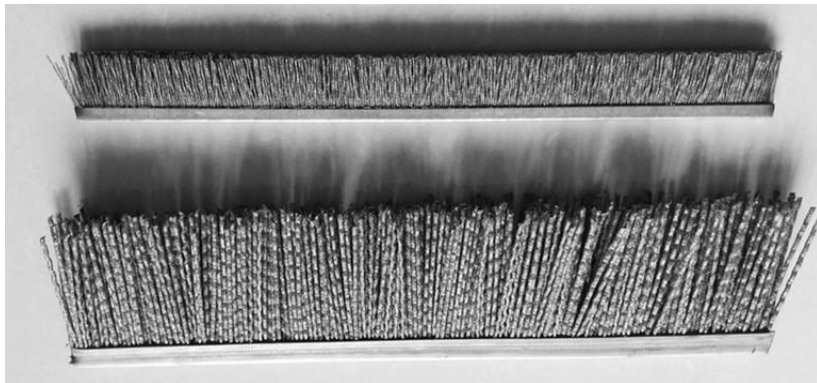

# 尺寸规格

# 孔 刷

# Dimension Specification Tube Brushes

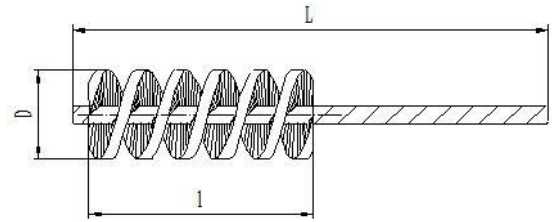
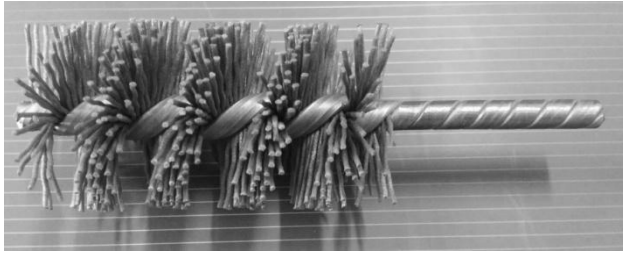

普通柄孔 tube brush with normal

handle

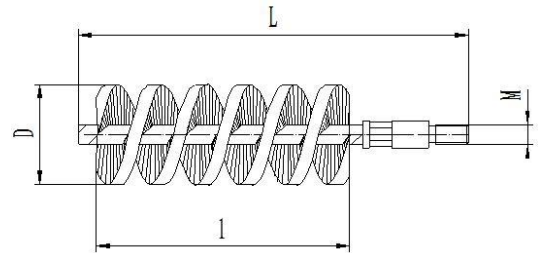
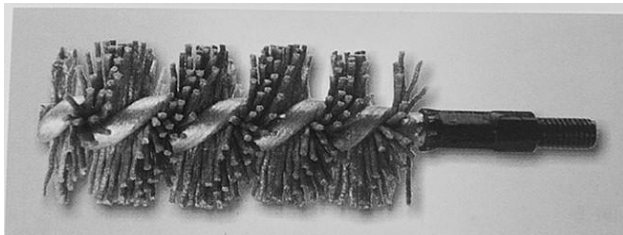
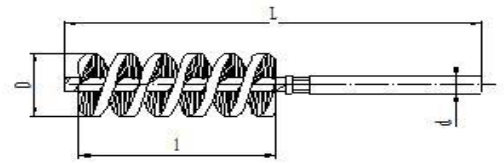
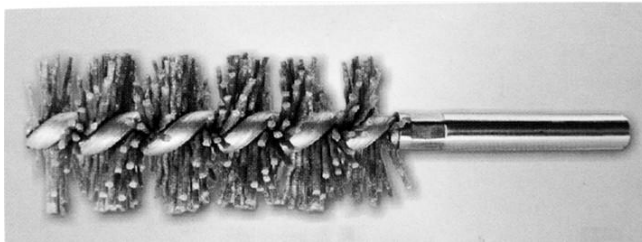

Tube brush with Cylindrical handle  
接圆柱柄孔刷

接螺纹柄孔刷 Tube brush with threading handle

标准尺寸表

mm

D	I	L
φ 4~φ 10	35	80
φ 11~φ 20	40	90
φ 21~φ 30	50	100
φ 31~φ 40	60	120
φ 41~φ 50	80	160



- 因为具有扭转性及均匀的凹凸紧随性，最适合螺丝孔、小孔管内径的清洁  
Suitable for thread holes, small hole ID cleaning due to its torsion and uniform bump
- 可以设置很长的刷柄，适合深邃处的毛刺清除及清洁  
can be design with long brush handle and suitable for removing burrs in deep bottom

Make as per customer's request 按用户需求提供定制

## 尺寸规格 盘 刷

Dimension Specification Disc Brush

尼龙体盘刷

Nylon Brush

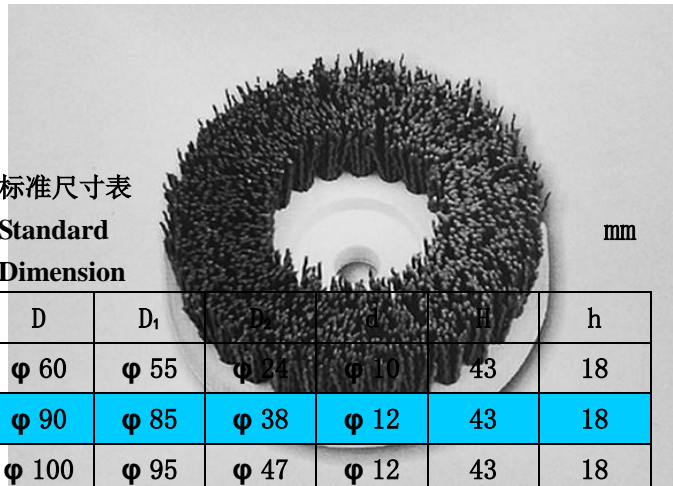

标准尺寸表  
Standard  
Dimension

mm

D	D <sub>1</sub>	D <sub>2</sub>	d	H	h
φ 60	φ 55	φ 24	φ 10	43	18
φ 90	φ 85	φ 38	φ 12	43	18
φ 100	φ 95	φ 47	φ 12	43	18
φ 125	φ 120	φ 72	φ 30	45	20
φ 140	φ 135	φ 85	φ 30	45	20
φ 165	φ 160	φ 100	φ 40	45	20

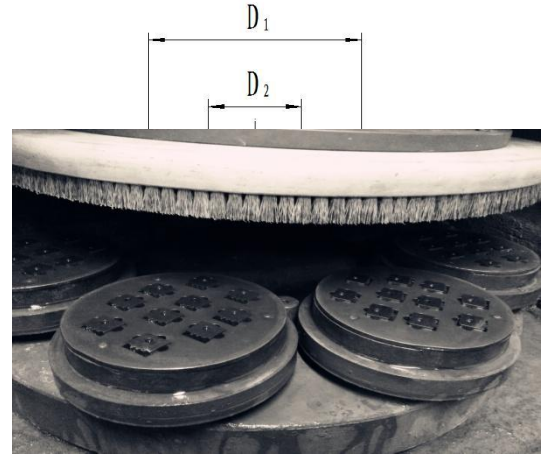

- 数控刀片涂层前的钝化抛光
- 各种金属产品的毛刺、锈

迹、污垢的清除

Remove burrs, rust, and dirt of various metal products

- 因特殊的加工方法，毛材无脱落现象，可放心使用

The brush material will not take off because of special processing, quality guaranteed for use.

- 在水或湿润环境下也可使用

Applicable in water or humid environment

Make as per customer request

按用户需求提供定制

## 尺寸规格 盘刷

Dimension Specification Disc Brush

钢体盘刷  
Steel Brush

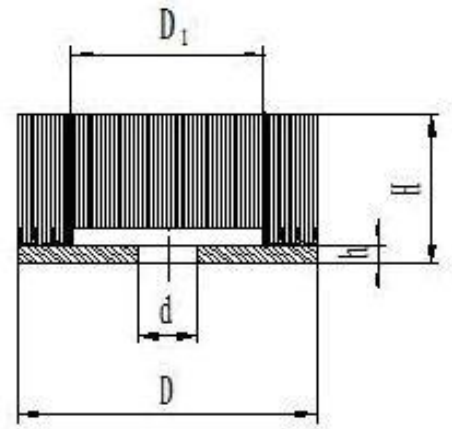
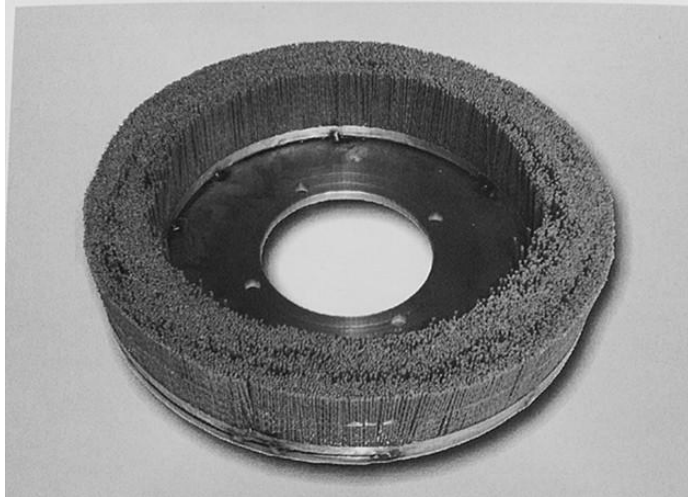

标准尺寸表

Standard  
Dimension

mm

D	D <sub>1</sub>	D <sub>2</sub>	d	H	h
φ 60	φ 32	φ 8	φ 10	30	4
φ 100	φ 58	φ 32	φ 12	50	5
φ 120	φ 78	φ 32	φ 12	50	6
φ 150	φ 108	φ 32	φ 30	50	6
φ 200	φ 144	φ 100	φ 30	56	6
φ 280	φ 224	φ 100	φ 40	56	6

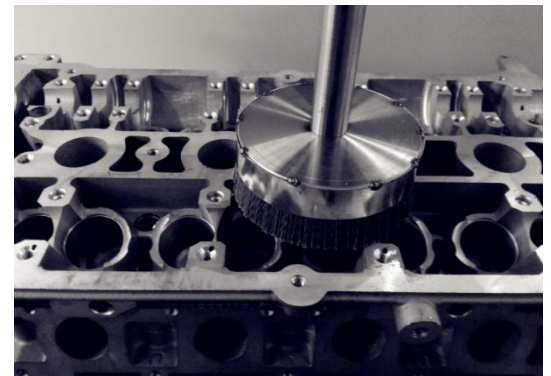

- 汽车零部件、油压、家电部件的毛刺清除、表面抛光

Remove burrs of auto parts, hydraulic press and electronic appliance part; surface polishing

- 各种金属产品的毛刺锈迹、污垢的清除

Remove of burrs, rust and dirt of various metal products

尺寸规格 Dimension specification

## 高密盘刷 High Density Disc Brush

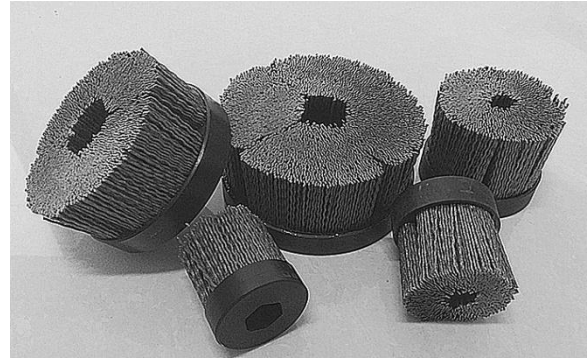
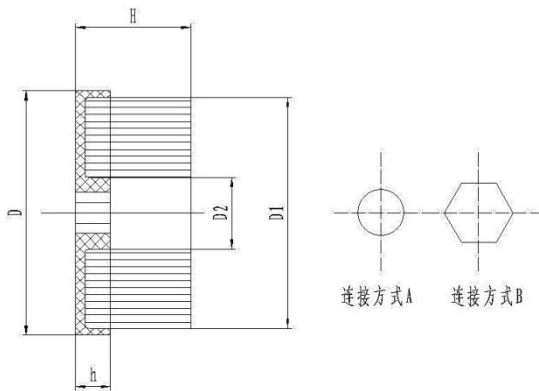

标准尺寸表 Standard Dimension					mm
d	D	D1	D2	H	h
φ 12	φ 67	φ 63	φ 24	55	15
φ 16	φ 86	φ 80	φ 44	50	15
正六边形 16 Regular hexagon 16	φ 42	φ 38	φ 16	50	13
正六边形 16 Regular hexagon 16	φ 50	φ 46	φ 22	50	15
正六边形 16 Regular hexagon 16	φ 106	φ 100	φ 35	50	15

## 发动机缸盖平面毛刺去除及抛光 Cylinder Block Surface De-burring and Polishing

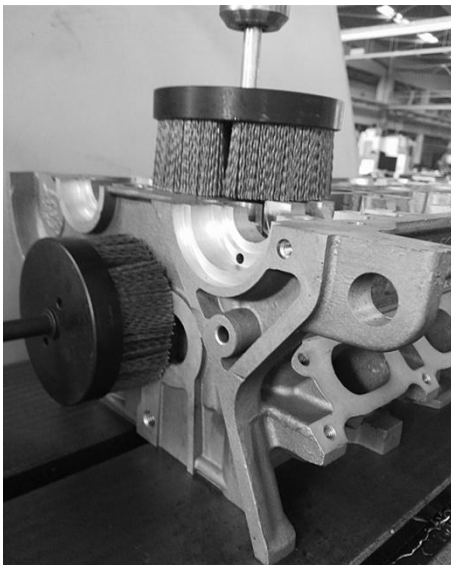

- 高密盘刷，毛丝密度高，强度大，磨削力提高，大大提高效率，大批量生产产家必备利器  
High density disc brush with high density filament, , high strength and improved grinding force has greatly improved the efficiency of mass production. A Must Buy product for mass production manufacturers.
- 汽车零部件、油压、家电部件等的毛刺清除、表面抛光  
Remove burrs of auto parts, hydraulic press and electronic appliance part; surface polishing
- 各种机械加工金属产品的毛刺锈迹、污垢的清除  
Remove of burrs, rust and dirt of various

metal products

按用户需求提供 Make as per customer request

尺寸规格 轮刷 Dimension Specification wheel brushes

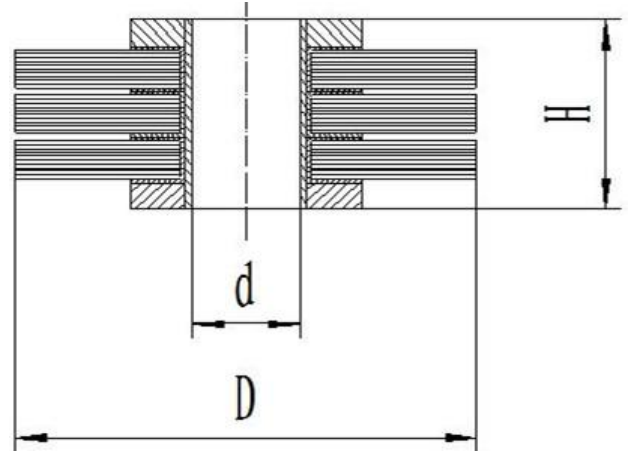
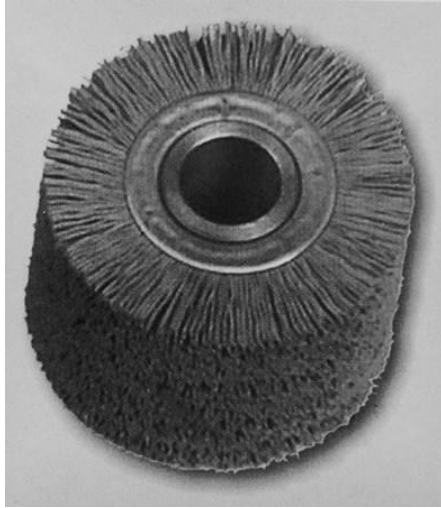

标准尺寸表 Standard dimension mm

d	D	H
$\phi 6 \sim \phi 20$		

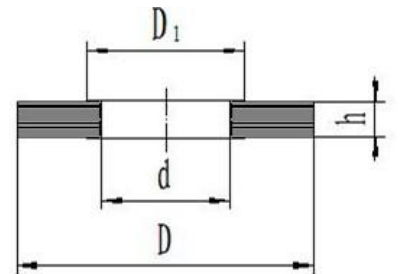

标准尺寸表 Standard dimension mm

d	D	h	D <sub>1</sub>
$\phi 10$	$\phi 30 \sim \phi 60$	6	$\phi 18$
$\phi 14$	$\phi 40 \sim \phi 80$	6	$\phi 23$
$\phi 22.2$	$\phi 50 \sim \phi 120$	7	$\phi 33$
$\phi 25.4$	$\phi 60 \sim \phi 130$	7	$\phi 35$

● 产品即使凹凸不平，也可以均匀的处理  
 Product with uneven surface can also be handled uniformly



- 可以作为单品使用或层叠毛刷使用，更为灵活方便

Can be used as single wheel brush or brushes with multiple layers, more convenient and flexible

- 管道内外径、螺纹沟槽的锈迹、毛刺清除、清洁

Remove rust and burrs from pipeline ID and OD, thread groove

- 齿轮，金属部件的毛刺清除及抛光

Remove burrs and polishing of gears and metal parts

按用户需求提供定制

Make as per customer's request

## 尺寸规格 轮刷

Dimension Specification Wheel Brush

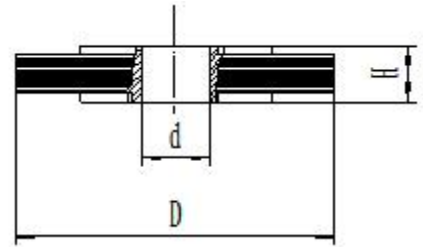
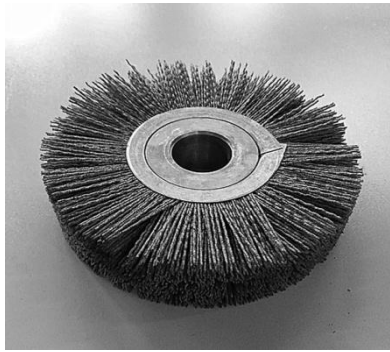

标准尺寸表

mm

d	D	H
φ 32	φ 150~φ 180	25/35/45

标准尺寸表 Standard Dimension

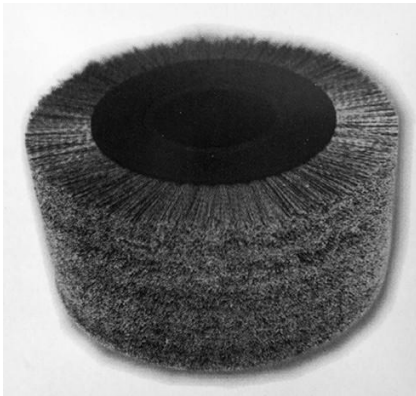

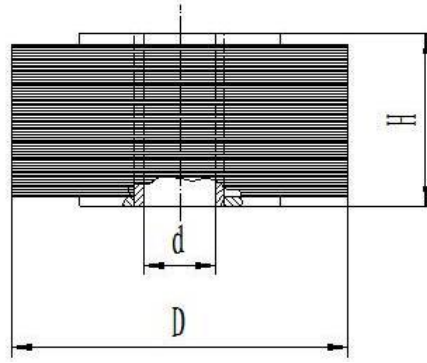

标准尺寸表

mm

d	D	H
φ 90~φ 200	φ 200~φ 400	40~300

标准尺寸表 Standard Dimension

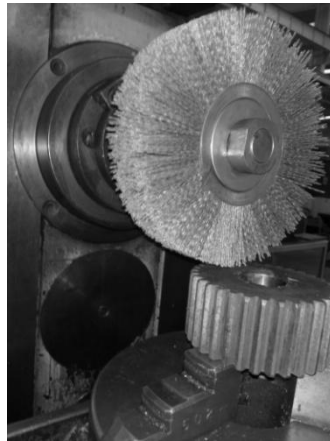

数控刀片涂层前的钝化抛光;  
**Passivation and polishing before coating for CNC inserts**  
 齿轮、金属部件的毛刺清除及抛光  
**Remove burrs and polishing of gears**

and metal parts

铁、非金属的电镀前处理

**Electroplating pre-treatment of iron and nonmetal**

具有优良的操作性，可进行精密研磨在水或湿润环境下也可使用

**Can be applied in water and humid environment for precise grinding**

**Make as per customer's request**

按用户需求提供定制

## 笔刷 . 条刷

**End Brush and Striped Brush**

### 笔刷 End Brush

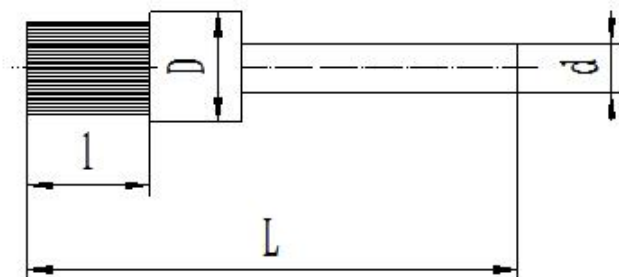
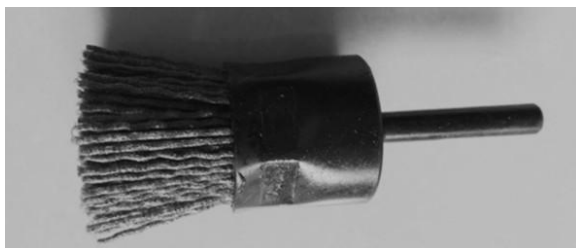



标准尺寸表

mm

D	I	L	d
φ 10	20	80	φ 6
φ 15	20	80	φ 6
φ 20	30	90	φ 8
φ 30	30	90	φ 8

标准尺寸表  
Standard  
Dimension

- 体型小，操作性能优良。角落部和孔底的毛刺清除、研磨、清洁

Small size with excellent operating performance. It can remove, grind and clean burrs in corner and bottom of the hole

- 具有优良的凹凸面和局部面紧随性和融合性

Excellent concave and convex surface

- 具有优良的凹凸面紧随性和局部融合性

shows excellent concave and convex surface continuity and local fusion



# 条刷 Striped Brush

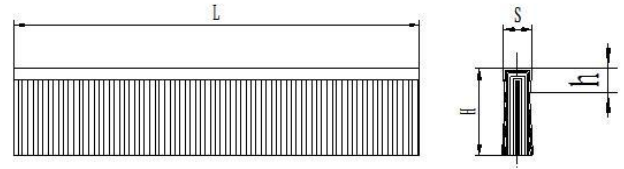
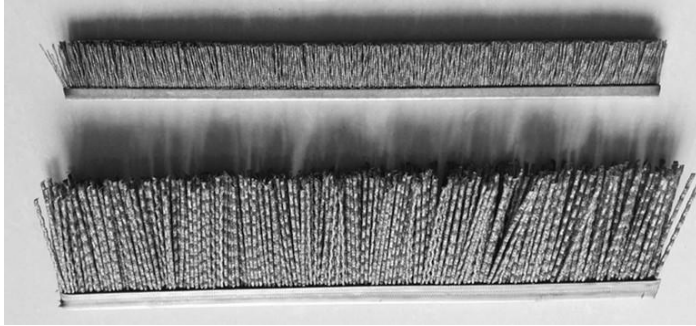

标准尺寸表 mm

L	H	h	s
210	17	4.7	4.7

标准尺寸表 standard Dimension